

SM3561M

4-20mA current type 200,000 wide range illuminance sensor

User Manual

File Version: V21.12.13



SM3561M using the standard DC4-20mA current output signal,easy access to PLC , DCS and other instruments or systems for monitoring Illuminance state quantities.The internal use of high-precision sensing core and related devices to ensure high reliability and excellent long-term stability,can be customized RS232,RS485,CAN,4-20mA,DC0~5V\10V,ZIGBEE,Lora,WIFI,GPRS and other output methods.

Technical Parameters

Technical parameter	Parameter value
---------------------	-----------------

Brand	SONBEST
Illuminance measuring range	0~20 000Lux
Illuminance allow deviation	± 7%
Repeatability test	± 5%
Illuminance detection chip	Import digital
Wavelength range	380nm~730nm
Communication Interface	DC4~20mA
Power	DC12~24V 1A
Running temperature	-40~80°C
Working humidity	5%RH~90%RH



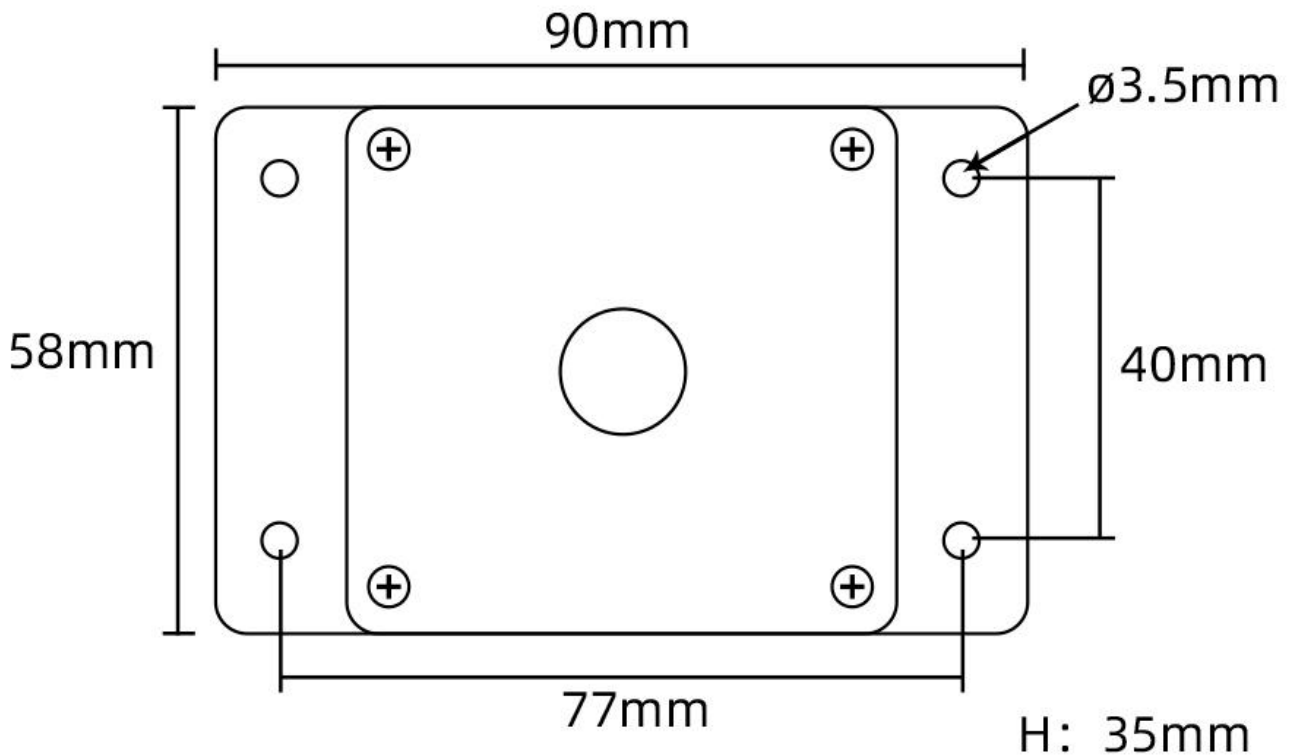

Product Size

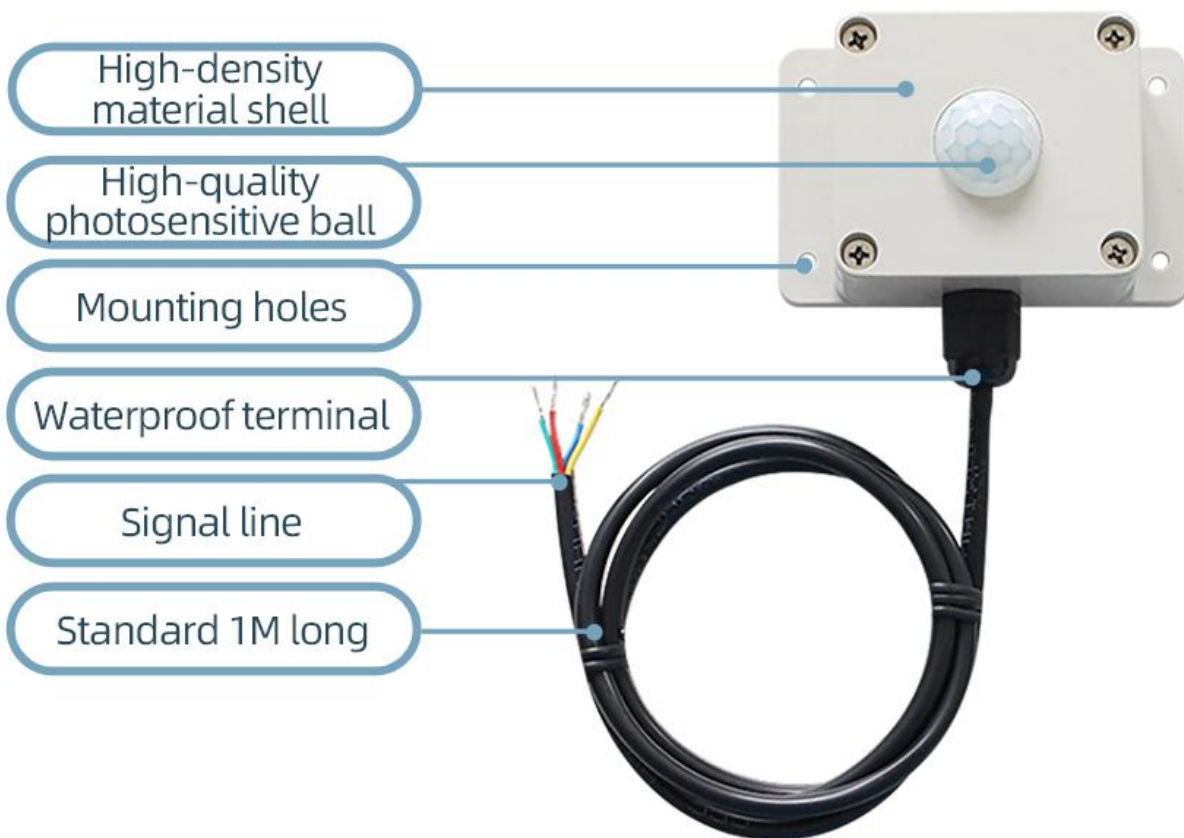



How to wiring?





RS485 Wire

	RD	PWR+
	GN	PWR-
	YE	RS485 A+
	BU	RS485 B-

Electric current wire

	RD	PWR+
	BK	PWR-
	BU	I OUT

Voltage wire

	RD	PWR+
	BK	PWR-
	BU	V OUT

※ Note: When wiring, first connect the positive and negative poles of the power supply, and then connect the signal line

Application solution

■ RS485 Wire



■ Electric current wire

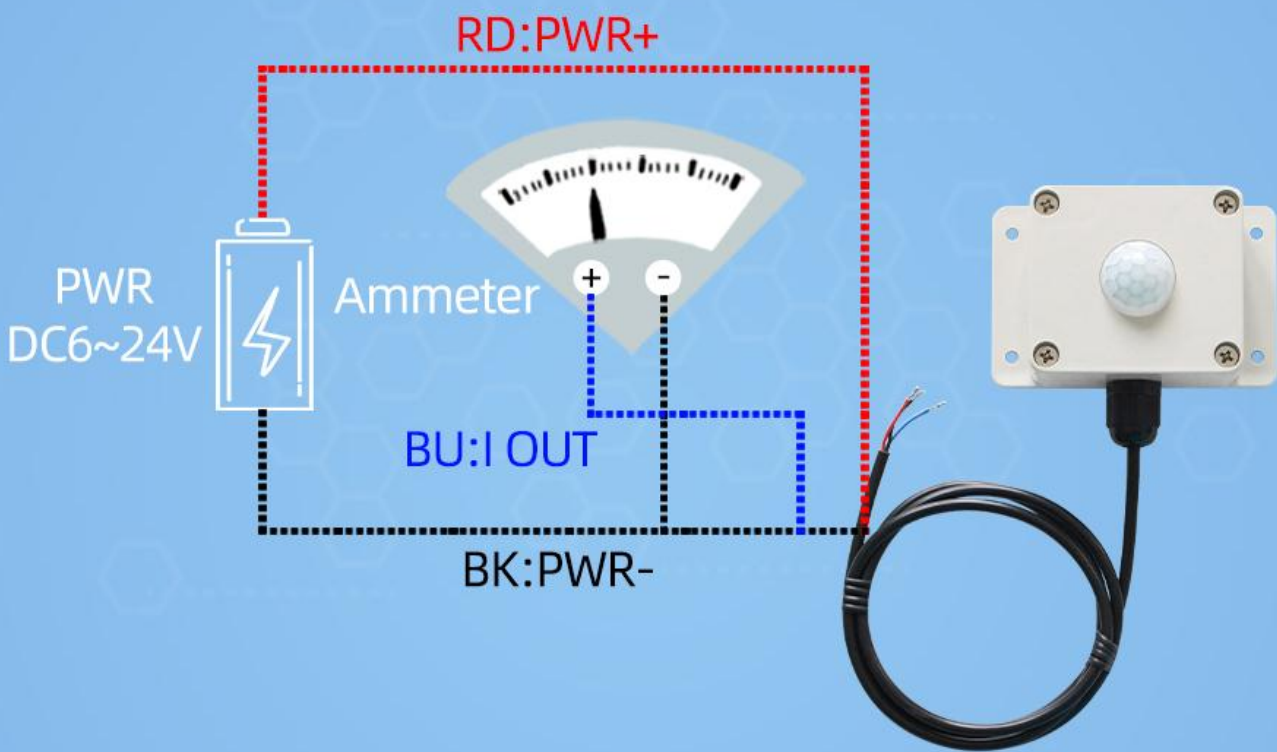

■ Voltage wire

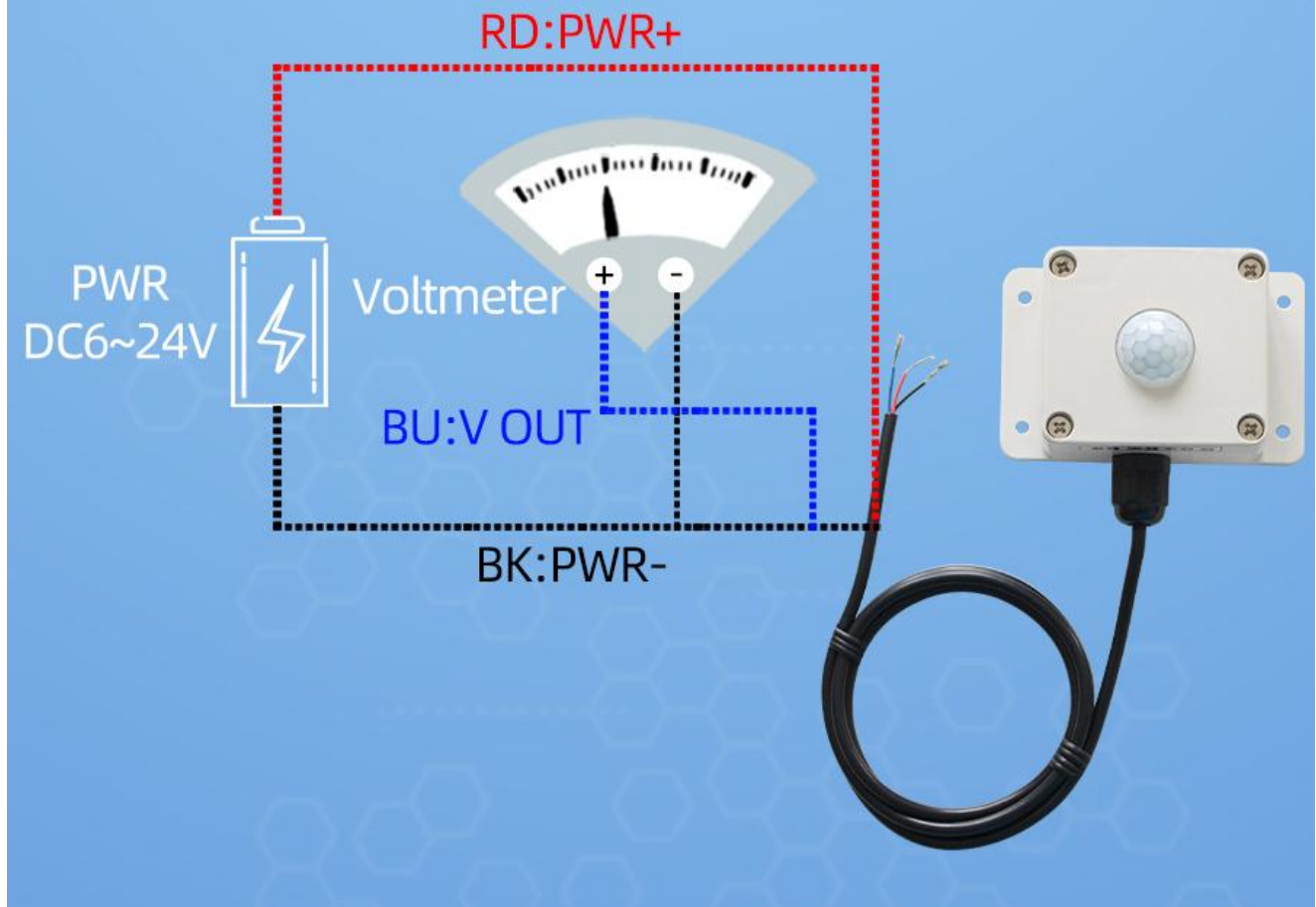

How to use?



Greenhouse

Cooperate with sensors to effectively manage, create a good lighting environment for crops, and promote better photosynthesis

Flower farming

Flower farming needs light management, according to the plant's light needs to cooperate with the sensor to control the light intensity



Building

The equipment used to measure the level of light intensity requires strict illumination requirements in certain specific environments



Disclaimer

This document provides all information about the product, does not grant any license to intellectual property, does not express or imply, and prohibits any other means of granting any intellectual property rights, such as the statement of sales terms and conditions of this product, other issues. No liability is assumed. Furthermore, our company makes no warranties, express or implied, regarding the sale and use of this product, including the suitability for the specific use of the product, the marketability or the infringement liability for any patent, copyright or other intellectual property rights, etc. Product specifications and product descriptions may be modified at any time without notice.

Contact Us

Company: Shanghai Sonbest Industrial Co., Ltd

Address: Building 8, No. 215 North east road, Baoshan District, Shanghai, China

Web: <http://www.sonbest.com>

Web: <http://www.sonbus.com>

SKYPE: soobuu

Email: sale@sonbest.com

Tel: 86-021-51083595 / 66862055 / 66862075 / 66861077