

KM53B83

User Manual

File Version: V21.5.14



KM53B83 using the standard ,easy access to PLC , DCS and other instruments or systems for monitoring conductivity state quantities.The internal use of high-precision sensing core and related devices to ensure high reliability and excellent long-term stability,can be customized

RS232,RS485,CAN,4-20mA,DC0~5V\10V,ZIGBEE,Lora,WIFI,GPRS and other output methods.

Technical Parameters

Technical parameter	Parameter value
Brand	KLHA
Wind direction range	0~360°
Wind direction resolution	22.5°
Interface	RS485/4-20mA/DC0-5V
Power	DC12~24V 1A
Running temperature	-40~80°C
Working humidity	5%RH~90%RH

Product Selection

Product Design RS485,4-20mA,DC0-5V Multiple output methods, the products are divided into the following models depending on the output method.





Product model	output method
KM53B8B	RS485 总线
KM53B8M	4-20mA
KM53B8V5	DC0-5V

Product Size





How to wiring?



RS485 Wiring

	RD	PWR+
	GN	PWR-
	YE	RS485 A+
	BU	RS485 B-



Pulse type wiring

	RD	PWR+
	BK	PWR-
	BU	Pulse output

Current type wiring

	RD	PWR+
	GN	PWR-
	YE	Current output

Voltage type wiring

	RD	PWR+
	GN	PWR-
	YE	Voltage output

※Note: When wiring, connect the positive and negative poles of the power supply first, and then connect the signal wire

Application solution

■ RS485 Wiring

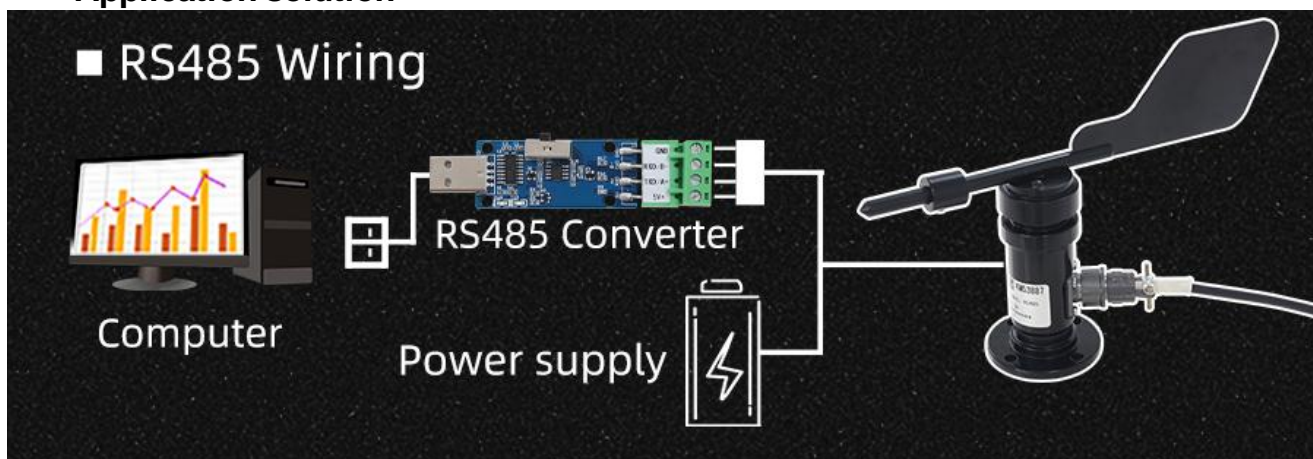

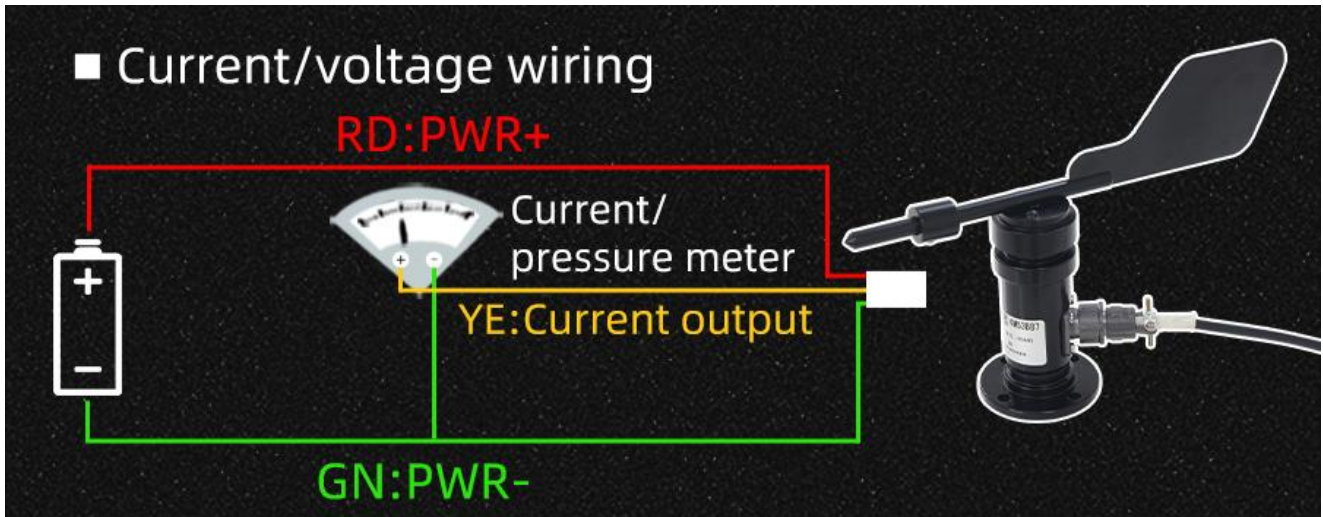

16 WIND DIRECTION MAP

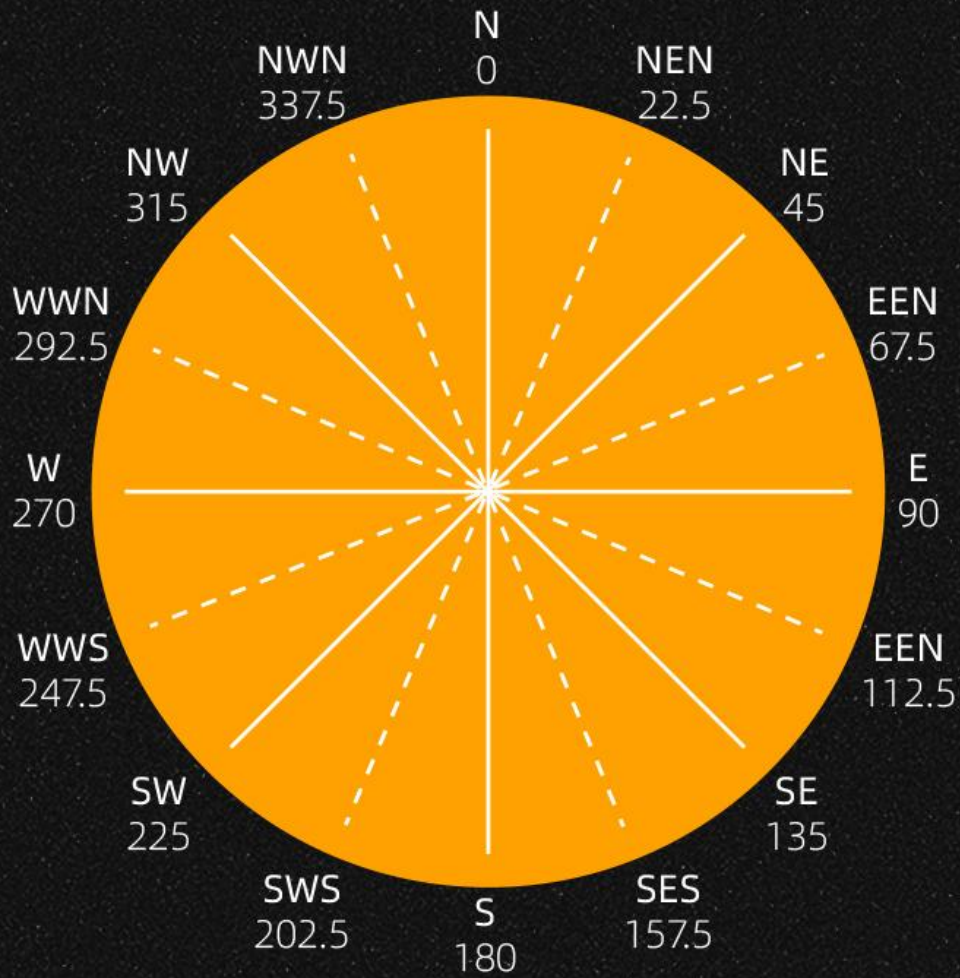

How to use?



Communication Protocol

The product uses RS485 MODBUS-RTU standard protocol format, all operation or reply commands are hexadecimal data. The default device address is 1 when the device is shipped, the default baud rate is 9600, 8, n, 1

1. Read Data (Function id 0x03)

Inquiry frame (hexadecimal), sending example: Query 1# device 1 data, the host computer sends the command:01 03 00 00 00 01 84 0A .

Device ID	Function id	Start Address	Data Length	CRC16
01	03	00 00	00 01	84 0A

For the correct query frame, the device will respond with data:01 03 02 00 79 79 A6 , the response format is parsed as follows:

Device ID	Function id	Data Length	数据 1	Check Code
01	03	02	00 79	79 A6

Data Description: The data in the command is hexadecimal. Take data 1 as an example. 00 79 is converted to a decimal value of 121. If the data magnification is 100, the actual value is 121/100=1.21. Others and so on.

2. Data Address Table

Address	Start Address	Description	Data type	Value range
40001	00 00	1#conductivityregister	Read only	0~65535
40101	00 64	model code	read/write	0~65535
40102	00 65	total points	read/write	1~20
40103	00 66	Device ID	read/write	1~249
40104	00 67	baud rate	read/write	0~6
40105	00 68	mode	read/write	1~4
40106	00 69	protocol	read/write	1~10

3 read and modify device address

(1) Read or query device address

If you don't know the current device address and there is only one device on the bus, you can use the command FA 03 00 64 00 02 90 5F Query device address.

Device ID	Function id	Start Address	Data Length	CRC16
FA	03	00 64	00 02	90 5F

FA is 250 for the general address. When you don't know the address, you can use 250 to get the real device address, 00 64 is the device model register.

For the correct query command, the device will respond, for example the response data is: 01 03 02 07 12 3A 79, the format of which is as shown in the following table:

Device ID	Function id	Start Address	Model Code	CRC16
01	03	02	55 3C 00 01	3A 79

Response should be in the data, the first byte 01 indicates that the real address of the current device is, 55 3C converted to decimal 20182 indicates that the current device main model is 21820, the last two bytes 00 01 Indicates that the device has a status quantity.

(2)Change device address

For example, if the current device address is 1, we want to change to 02, the command is:01 06 00 66 00 02 E8 14 .

Device ID	Function id	Start Address	Destination	CRC16
01	06	00 66	00 02	E8 14

After the change is successful, the device will return information: 02 06 00 66 00 02 E8 27 , its format is parsed as shown in the following table:

Device ID	Function id	Start Address	Destination	CRC16
01	06	00 66	00 02	E8 27

Response should be in the data, after the modification is successful, the first byte is the new device address. After the general device address is changed, it will take effect immediately. At this time, the user needs to change the query command of the software at the same time.

4 Read and Modify Baud Rate

(1) Read baud rate

The device default factory baud rate is 9600. If you need to change it, you can change it according to the following table and the corresponding communication protocol. For example, read the current device's baud rate ID, the command is:01 03 00 67 00 01 35 D5 , its format is parsed as follows.

Device ID	Function id	Start Address	Data Length	CRC16
01	03	00 67	00 01	35 D5

Read the baud rate encoding of the current device. Baud rate encoding: 1 is 2400; 2 is 4800; 3 is 9600; 4 is 19200; 5 is 38400; 6 is 115200.

For the correct query command, the device will respond, for example the response data is: 01 03 02 00 03 F8 45, the format of which is as shown in the following table:

Device ID	Function id	Data Length	Rate ID	CRC16
01	03	02	00 03	F8 45

coded according to baud rate, 03 is 9600, ie the current device has a baud rate of 9600.

(2)Change the baud rate

For example, changing the baud rate from 9600 to 38400, ie changing the code from 3 to 5, the command is: 01 06 00 67 00 05 F8 1601 03 00 66 00 01 64 15 .

Device ID	Function id	Start Address	Target Baud Rate	CRC16
01	03	00 66	00 01	64 15

Change the baud rate from 9600 to 38400, changing the code from 3 to 5. The new baud rate will take effect immediately, at which point the device will lose its response and the baud rate of the device should be queried accordingly. Modified.

5 Read Correction Value

(1) Read Correction Value

When there is an error between the data and the reference standard, we can reduce the display error by adjusting the correction value. The correction difference can be modified to be plus or minus 1000, that is, the value range is 0-1000 or 64535 -65535. For example, when the display value is too small, we can correct it by adding 100. The command is: 01 03 00 6B 00 01 F5 D6 . In the command 100 is hex 0x64 If you need to reduce, you can set a negative value, such as -100, corresponding to the hexadecimal value of FF 9C, which is calculated as 100-65535=65435, and then converted to hexadecimal to 0x FF 9C. The correction value starts from 00 6B. We take the first parameter as an example. The correction value is read and modified in the same way for multiple parameters.

Device ID	Function id	Start Address	Data Length	CRC16
01	03	00 6B	00 01	F5 D6

For the correct query command, the device will respond, for example the response data is: 01 03 02 00 64 B9 AF, the format of which is as shown in the following table:

Device ID	Function id	Data Length	Data value	CRC16
01	03	02	00 64	B9 AF

In the response data, the first byte 01 indicates the real address of the current device, and 00 6B is the first state quantity correction value register. If the device has multiple parameters, other parameters operate in this way. The same, the general temperature, humidity have this parameter, the light generally does not have this item.

(2)Change correction value

For example, the current state quantity is too small, we want to add 1 to its true value, and the current value plus 100 correction operation command is:01 06 00 6B 00 64 F9 FD .

Device ID	Function id	Start Address	Destination	CRC16
01	06	00 6B	00 64	F9 FD

After the operation is successful, the device will return information: 01 06 00 6B 00 64 F9 FD, the parameters take effect immediately after successful change.

For example, the range is 0~360°, the analog output is 4~20mA current signal, conductivity and current The calculation relationship is as shown in the formula: $C = (A2-A1) * (X-B1) / (B2-B1) + A1$, where A2 is conductivity range upper limit, A1 is the lower limit of the range, B2 is current output range upper limit, B1 is the lower limit, X is the currently read conductivity value, and C is the calculated current value. The list of commonly used values is as follows:

current(mA)	conductivityValue (°)	Calculation Process
4	0.0	$(360-0)*(4-4)÷(20-4)+0$
5	22.5	$(360-0)*(5-4)÷(20-4)+0$
6	45.0	$(360-0)*(6-4)÷(20-4)+0$
7	67.5	$(360-0)*(7-4)÷(20-4)+0$
8	90.0	$(360-0)*(8-4)÷(20-4)+0$
9	112.5	$(360-0)*(9-4)÷(20-4)+0$
10	135.0	$(360-0)*(10-4)÷(20-4)+0$

11	157.5	$(360-0)*(11-4)\div(20-4)+0$
12	180.0	$(360-0)*(12-4)\div(20-4)+0$
13	202.5	$(360-0)*(13-4)\div(20-4)+0$
14	225.0	$(360-0)*(14-4)\div(20-4)+0$
15	247.5	$(360-0)*(15-4)\div(20-4)+0$
16	270.0	$(360-0)*(16-4)\div(20-4)+0$
17	292.5	$(360-0)*(17-4)\div(20-4)+0$
18	315.0	$(360-0)*(18-4)\div(20-4)+0$
19	337.5	$(360-0)*(19-4)\div(20-4)+0$
20	360.0	$(360-0)*(20-4)\div(20-4)+0$

As shown in the above formula, when measuring 8mA, current current is 94°。

For example, the range is 0~360°, the analog output is 0~5V DC0-5Vvoltage signal, conductivity and DC0-5Vvoltage The calculation relationship is as shown in the formula: $C = (A2-A1) * (X-B1) / (B2-B1) + A1$, where A2 is conductivity range upper limit, A1 is the lower limit of the range, B2 is DC0-5Vvoltage output range upper limit, B1 is the lower limit, X is the currently read conductivity value, and C is the calculated DC0-5Vvoltage value. The list of commonly used values is as follows:

DC0-5Vvoltage(V)	conductivityValue (°)	Calculation Process
0	0.0	$(360-0)*(0-0)\div(5-0)+0$
1	72.0	$(360-0)*(1-0)\div(5-0)+0$
2	144.0	$(360-0)*(2-0)\div(5-0)+0$
3	216.0	$(360-0)*(3-0)\div(5-0)+0$
4	288.0	$(360-0)*(4-0)\div(5-0)+0$
5	360.0	$(360-0)*(5-0)\div(5-0)+0$

As shown in the above formula, when measuring 2.5V, current DC0-5Vvoltage is 180°。

Disclaimer

This document provides all information about the product, does not grant any license to intellectual property, does not express or imply, and prohibits any other means of granting any intellectual property rights, such as the statement of sales terms and conditions of this product, other issues. No liability is assumed. Furthermore, our company makes no warranties, express or implied, regarding the sale and use of this product, including the suitability for the specific use of the product, the marketability or the infringement liability for any patent, copyright or other intellectual property rights, etc. Product specifications and product descriptions may be modified at any time without notice.

Contact Us

Company: Shanghai Sonbest Industrial Co., Ltd KLHA Brand Division

Address: Building 8, No.215 North east road, Baoshan District, Shanghai, China

Web: <http://www.klha.com>

Web: <http://www.klha.com>

SKYPE: soobuu

Email: sale@sonbest.com

Tel: 86-021-51083595 / 66862055 / 66862075 / 66861077