

## SM6388B

### User Manual

File Version: V21.11.15



SM6388B using the standard RS485 bus MODBUS-RTU protocol, easy access to PLC, DCS and other instruments or systems for monitoring temperature、humidity、辅照度, atmospheric pressure state quantities. The internal use of high-precision sensing core and related devices to ensure high reliability and

excellent long-term stability, can be customized

RS232, RS485, CAN, 4-20mA, DC0~5V\10V, ZIGBEE, Lora, WIFI, GPRS and other output methods.

### Technical Parameters



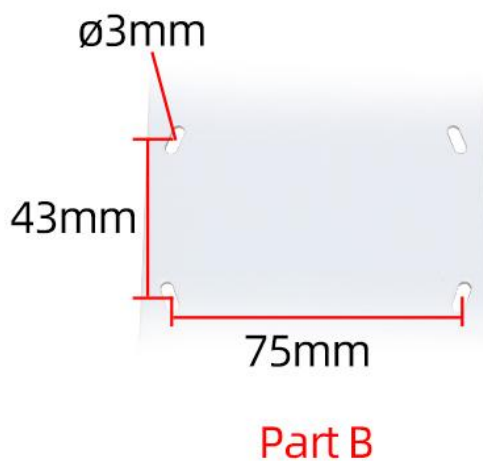
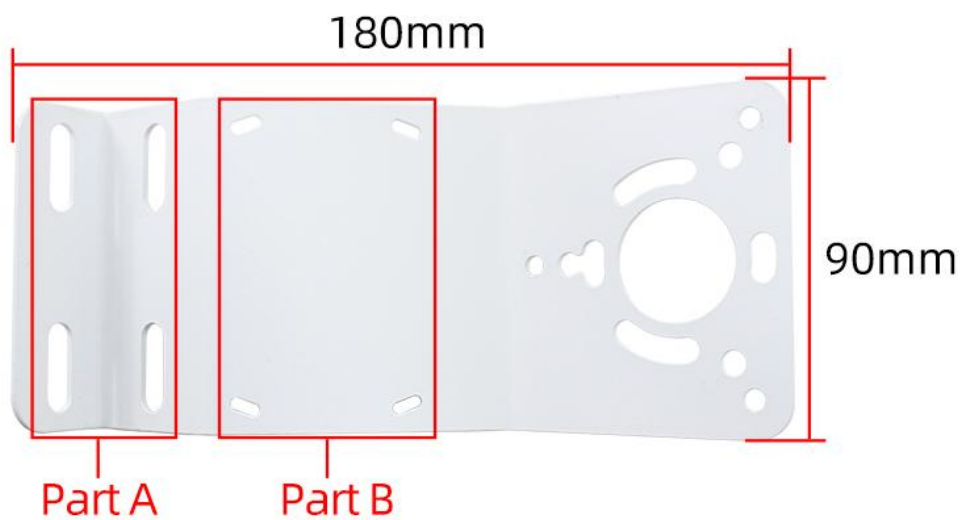

Technical parameter	Parameter value
Brand	SONBEST
Temperature measuring range	-30°C~80°C
Temperature measuring accuracy	±0.5°C @25°C
Atmospheric pressure range	30~110kpa
Atmospheric pressure accuracy	±0.5%
Communication Interface	RS485
Default baud rate	9600 8 n 1
Power	DC9~24V 1A
Running temperature	-40~80°C
Working humidity	5%RH~90%RH

### Product Size





**How to wiring?**

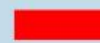

RS485 Wiring

	RD	PWR+
	GN	PWR-
	YE	RS485 A+
	BU	RS485 B-

4~20mA Wiring

	RD	PWR+
	BK	PWR-
	BU	I OUT

0~5V/10V Wiring

	RD	PWR+
	BK	PWR-
	BU	V OUT

※Note: When wiring, connect the positive and negative poles of the power supply first, then connect the signal wire

**Application solution**

■ RS485 Wiring

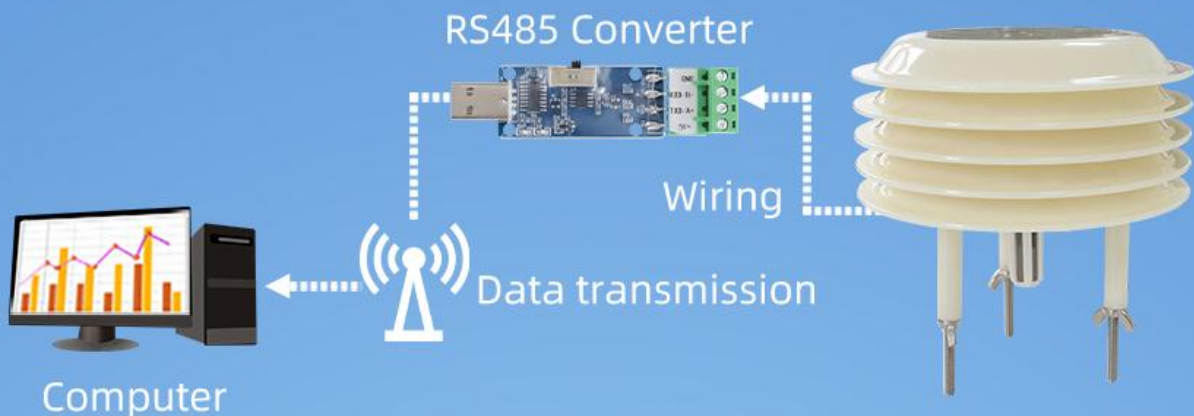

■ 4~20mA Wiring

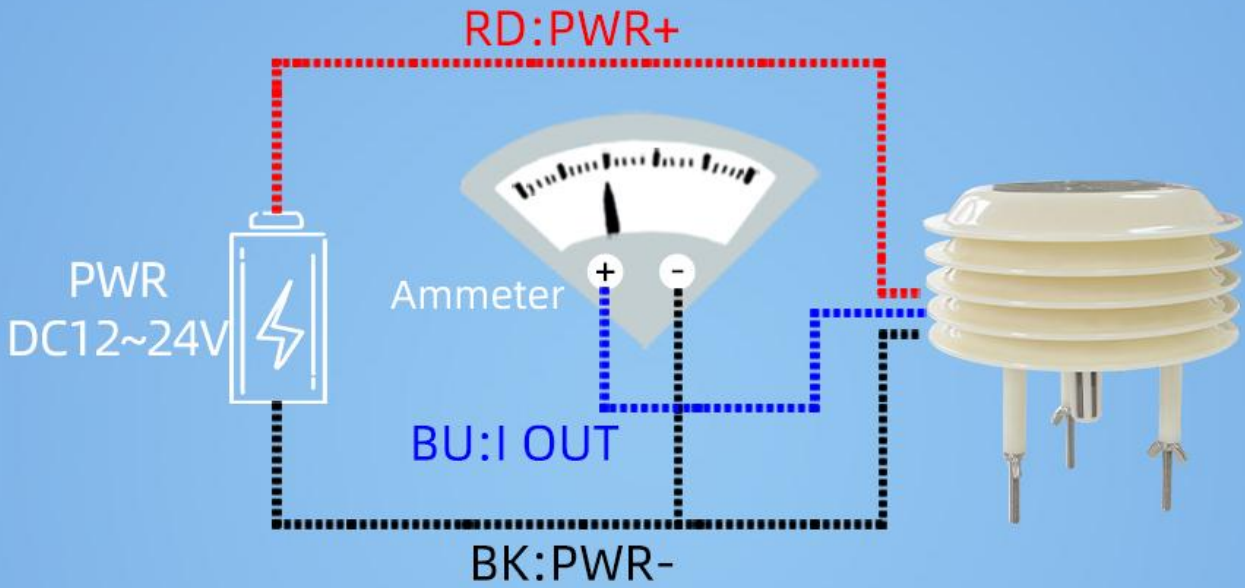

■ 0~5V/10V Wiring

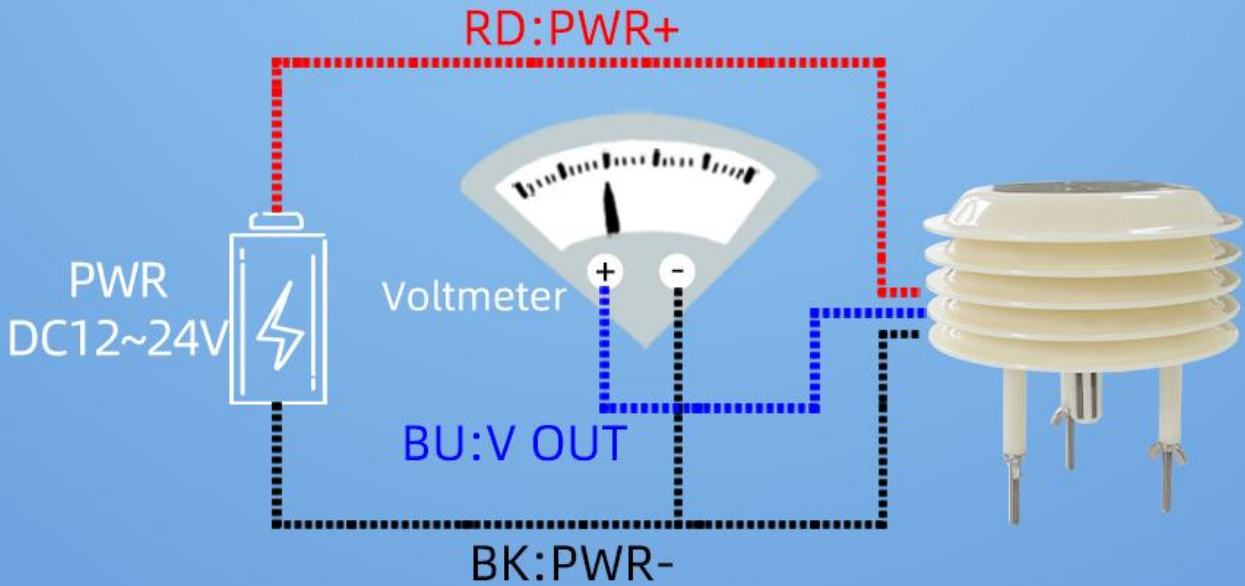

**How to use?**



## Communication Protocol Disclaimer

This document provides all information about the product, does not grant any license to intellectual property, does not express or imply, and prohibits any other means of granting any intellectual property rights, such as the statement of sales terms and conditions of this product, other issues. No liability is assumed. Furthermore, our company makes no warranties, express or implied, regarding the sale and use of this product, including the suitability for the specific use of the product, the marketability or the infringement liability for any patent, copyright or other intellectual property rights, etc. Product specifications and product descriptions may be modified at any time without notice.

### Contact Us

Company: Shanghai Sonbest Industrial Co., Ltd

Address: Building 8, No.215 North east road, Baoshan District, Shanghai, China

Web: <http://www.sonbest.com>

Web: <http://www.sonbus.com>

SKYPE: soobuu

Email: [sale@sonbest.com](mailto:sale@sonbest.com)

Tel: 86-021-51083595 / 66862055 / 66862075 / 66861077