

SM6389B

Small weather station shutters multi-function sens

User Manual

File Version: V23.7.3



SM6389B using the standard RS485 bus MODBUS-RTU protocol, easy access to PLC, DCS and other instruments or systems for monitoring temperature, humidity, Illuminance state quantities. The internal use of high-precision sensing core and related devices to ensure high reliability and excellent long-term stability, can be customized RS232, RS485, CAN, 4-20mA, DC0~5V\10V, ZIGBEE, Lora, WIFI, GPRS and other output methods.

Technical Parameters

Technical parameter	Parameter value
Brand	SONBEST
Temperature measuring range	-30℃~80℃
Temperature measuring accuracy	±0.5℃ @25℃
Illuminance measuring range	0~65535Lux
Illuminance allow deviation	±7%
Repeatability test	±5%
Illuminance detection chip	Import digital
Wavelength range	380nm~730nm
Communication Interface	RS485
Default baud rate	9600 8 n 1
Power	DC9~24V 1A
Running temperature	-30~85℃
Working humidity	5%RH~90%RH

Product Size

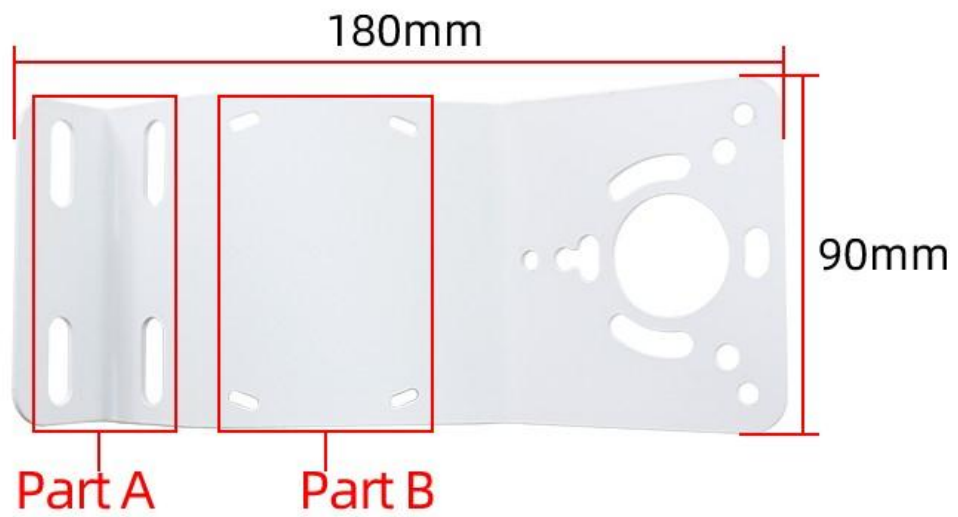



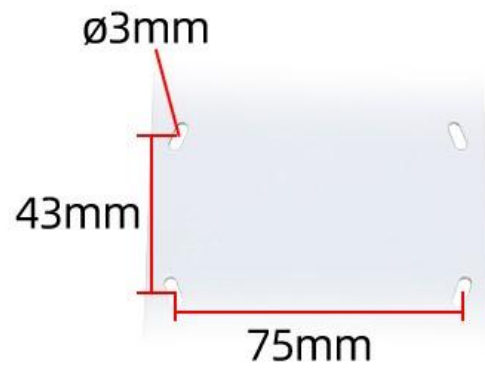

Part A



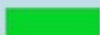

Part B

Wiring mode

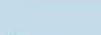

RS485 Wiring

	RD	PWR+
	GN	PWR-
	YE	RS485 A+
	BU	RS485 B-

4~20mA Wiring

	RD	PWR+
	BK	PWR-
	BU	I OUT

0~5V/10V Wiring

	RD	PWR+
	BK	PWR-
	BU	V OUT

※Note: When wiring, connect the positive and negative poles of the power supply first, then connect the signal wire

Wiring instructions

In the case of broken wires, wire the wires as shown in the figure. If the product itself has no leads, the core color is for reference.

How to use?

Louver box weather station sensor can be widely used in school teaching, park environment, construction site factory, grassland pasture, garden farmland and other outdoor scenes



Application solution

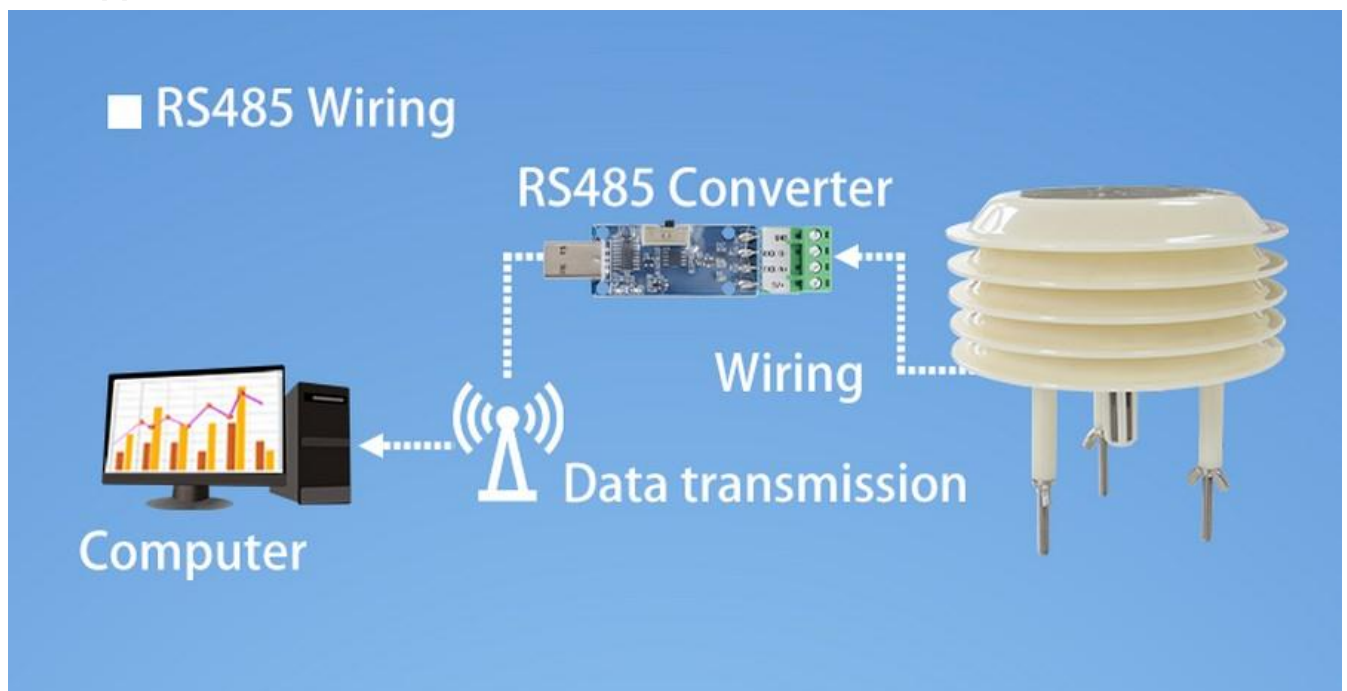

■ 4~20mA Wiring

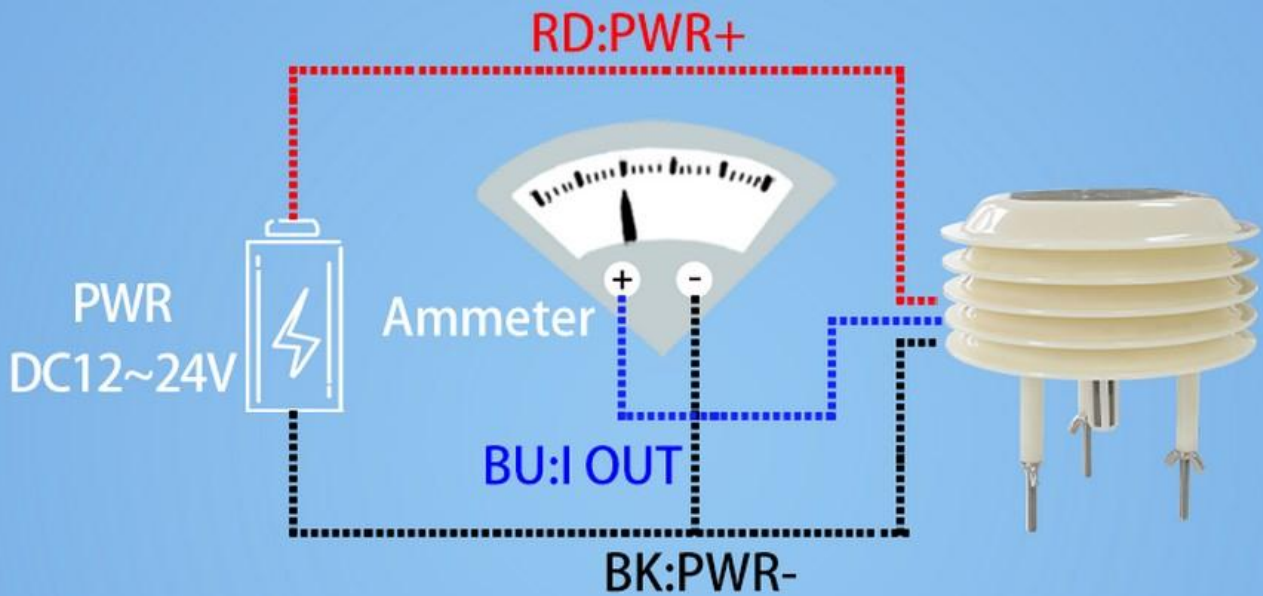

■ 0~5V/10V Wiring

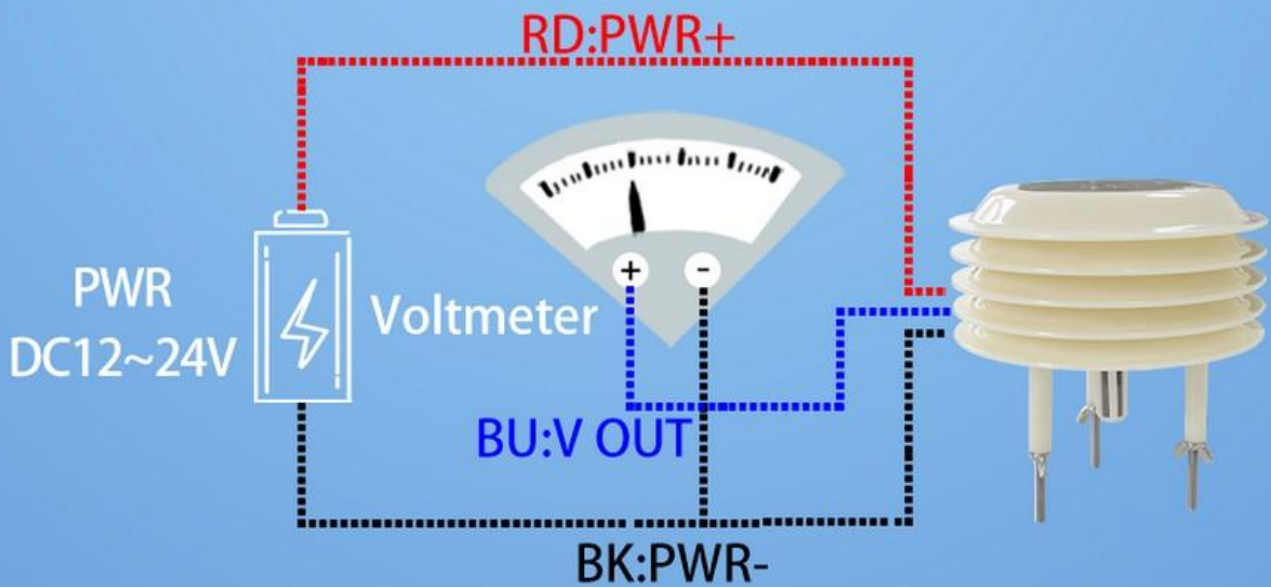

Product List



Shutter box

(select delivery according to parameters)



Warm reminder card



Small louver box iron bracket



Certificate of conformity

Communication Protocol Disclaimer

This document provides all information about the product, does not grant any license to intellectual property, does not express or imply, and prohibits any other means of granting any intellectual property rights, such as the statement of sales terms and conditions of this product, other issues. No liability is assumed. Furthermore, our company makes no warranties, express or implied, regarding the sale and use of this product, including the suitability for the specific use of the product, the marketability or the infringement liability for any patent, copyright or other intellectual property rights, etc. Product specifications and product descriptions may be modified at any time without notice.

Contact Us

Company: Shanghai Sonbest Industrial Co., Ltd

Address: Building 8, No.215 North east road, Baoshan District, Shanghai, China

Web: <http://www.sonbest.com>

Web: <http://www.sonbus.com>

SKYPE: soobuu

Email: sale@sonbest.com

Tel: 86-021-51083595 / 66862055 / 66862075 / 66861077